

























1	2	3	4	5
Kugelhahn 	RL-Temp. Begrenzer 	Pumpe 	Thermometer 	VL Puffer Vorlauf 
Regelventil 	Begrenzungsventil 	Bypass Thermostat 	Manometer 	RL Puffer Rücklauf 
Rückschlagventil 	Differenzdruckregler 	Zonenventil 	Fühler 	KW Kaltwasser 
Schmutzfänger 	PM-Regler 	Entlüftung 	Fühlermuffe WMZ 	WW Warmwasser 
				VL-HK Heizkörper VL 
				RL-HK Heizkörper RL 
				HT-VL Hochtemp. VL 
				HT-RL Hochtemp. RL 



Alle Anschlüsse 3/4" AG
 WW-Passtück 3/4"x80mm
 KW-Passtück 3/4"x80mm
 WMZ-Passtück 3/4"x110mm
 Fühlermuffe WMZ 1/2" IG

LME | Hydraulikschemata | Wohnungsstation Radiatoren mit PM (36 kW / 45 kW)

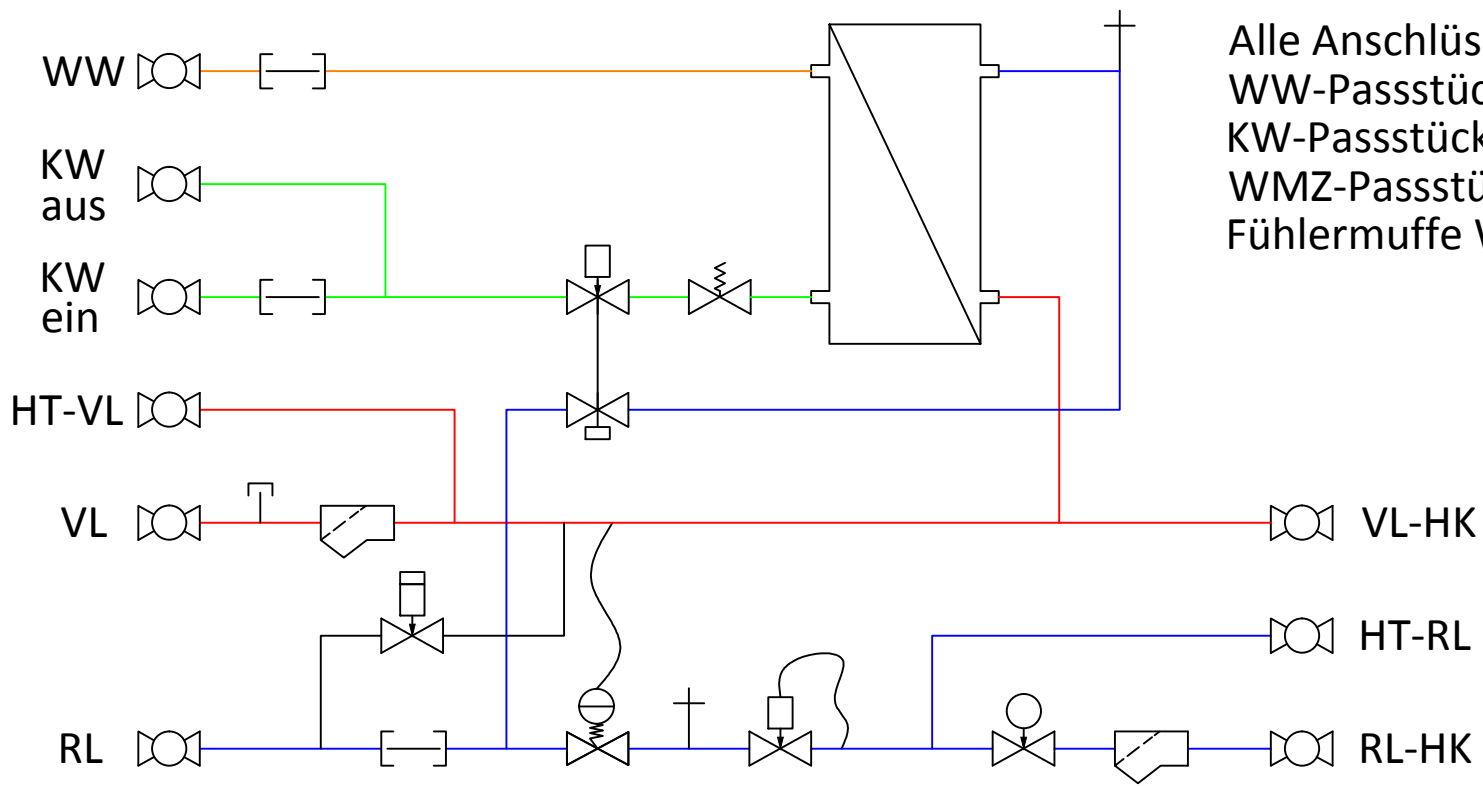

LME GmbH

**Ihr zuverlässiger Partner
für Energiesparheizsysteme**



+43 (0)664-33 62 396

LME GmbH
 Hohen-Stein-Straße 21
 A-4111 Walding
www.lme.co.at