

























1	2	3	4	5	
Kugelhahn 	RL-Temp. Begrenzer 	Pumpe 	Thermometer 	VL Puffer Vorlauf 	VL-HK Heizkörper VL 
Regelventil 	Begrenzungsventil 	Bypass Thermostat 	Manometer 	RL Puffer Rücklauf 	RL-HK Heizkörper RL 
Rückschlagventil 	Differenzdruckregler 	Zonenventil 	Fühler 	KW Kaltwasser 	HT-VL Hochtemp. VL 
Schmutzfänger 	PM-Regler 	Entlüftung 	Fühlermuffe WMZ 	WW Warmwasser 	HT-RL Hochtemp. RL 

E-Druchlauferhitzer

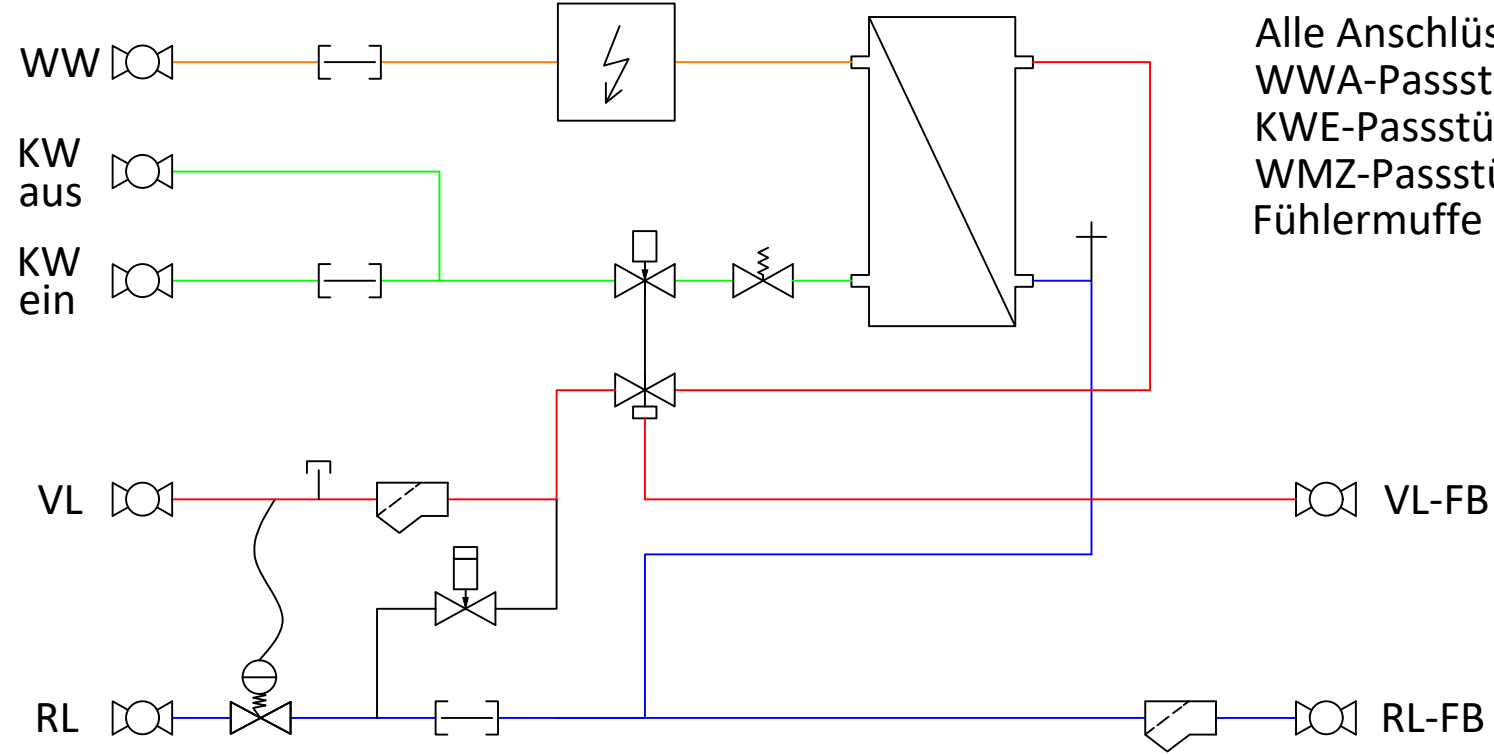

Alle Anschlüsse 3/4" AG
 WWA-Passstück 3/4"x81mm
 KWE-Passstück 3/4"x81mm
 WMZ-Passstück 3/4"x111mm
 Fühlermuffe WMZ 1/2" IG

LME | Hydraulikschemata | Wohnungsstation Warmwasser + FB-Heizung direkt + Elektronachheizung



**Ihr zuverlässiger Partner
für Energiesparheizsysteme**

+43 (0)664-33 62 396

LME GmbH
 Mühlkreisbahnstr. 22
 A-4111 Walding
 www.lme.co.at